

6. MDD 065

6.1. Technical Data

Designation	Symbol	Unit	Motor type MDD ...			
			065 A-N-040	065 B-N-040	065 C-N-040	065 D-N-040
Nominal motor speed ¹⁾	n	min ⁻¹	4000	4000	4000	4000
Continuous torque at standstill ²⁾	M_{dN}	Nm	0.8	1.5 (1.7) ⁵⁾	2.1 (2.7) ⁵⁾	2.7 (3.5) ⁵⁾
Continuous current at standstill	I_{dN}	A	1.8	3,5 (4.0) ⁵⁾	5.5 (7.1) ⁵⁾	6.3 (8.1) ⁵⁾
Theor. maximum torque ³⁾	M_{max}	Nm	2.3	4,4	6.1	7.8
Peak current	I_{max}	A	8.1	15.9	24.6	28.5
Rotor moment of inertia ⁴⁾	J_M	kgm ²	1.4×10^{-4}	2.2×10^{-4}	3.0×10^{-4}	3.8×10^{-4}
Torque constant at 20 °C	K_m	Nm/A	0.44	0.43	0.38	0.43
Windings resistance at 20 °C	R_A	Ohm	16	5.22	2.25	2.0
Windings inductance	L_A	mH	20.3	7.4	3.6	2.6
Thermal time constant	T_{th}	min	30	30 (15) ⁵⁾	30 (15) ⁵⁾	30 (15) ⁵⁾
Mass ⁴⁾	m_M	kg	3.2	3.9	4.6	5.3
			065 A-N-060	065 B-N-060	065 C-N-060	065 D-N-060
Nominal motor speed ¹⁾	n	min ⁻¹	6000	6000	6000	6000
Continuous torque at standstill ²⁾	M_{dN}	Nm	0.8	1.5 (1.7) ⁵⁾	2.1 (2.7) ⁵⁾	2.7 (3.5) ⁵⁾
Continuous current at standstill	I_{dN}	A	2.6	5.9 (6.7) ⁵⁾	7.9 (10.2) ⁵⁾	10.3 (13.3) ⁵⁾
Theor. maximum torque ³⁾	M_{max}	Nm	2.3	4.4	6.1	7.8
Peak current	I_{max}	A	11.6	26.3	35.4	46.2
Rotor moment of inertia ⁴⁾	J_M	kgm ²	1.4×10^{-4}	2.2×10^{-4}	3.0×10^{-4}	3.8×10^{-4}
Torque constant at 20 °C	K_m	Nm/A	0.31	0.26	0.27	0.26
Windings resistance at 20 °C	R_A	Ohm	7.75	2.0	1.16	0.74
Windings inductance	L_A	mH	6.4	2.2	1.3	0.9
Thermal time constant	T_{th}	min	30	30 (15) ⁵⁾	30 (15) ⁵⁾	30 (15) ⁵⁾
Mass ⁴⁾	m_M	kg	3.2	3.9	4.6	5.3

1) Usable motor speed is determined by the torque requirements of the application. The usable speed n_{max} found in the selection lists of the motor-drive combinations are binding for **standard applications**. The usable speed for other applications can be found using the required torque in the torque-speed characteristics curves.

2) With 60 K overtemperature at the motor housing.

3) Achievable maximum torque is dependent upon the drive used. **Only** those maximum torques M_{max} found in the selection list of the motor-drive combinations are binding.

4) without blocking brake

5) Parenthetical values apply to motors with surface cooling

Fig 6.1: Type dependent motor data

Designation	Symbol	Unit	Data
Permissible ambient temperature	T_{um}	°C	0 ... + 45
Permissible storage and transport temperatures	T_L	°C	-20 ... + 80
Maximum installation elevation		m	1000 meters above sea level
Protection category			IP 65
Insulation classification			F
Housing coat			Black prime coat (RAL 9005)

Fig 6.2: General data - MDD 065

Designation	Symbol	Unit	Blocking Brake Data
Principle of action			electrically actuated release
Holding torque	M_H	Nm	3.0
Nominal voltage	U_N	V	DC 24 ± 10%
Nominal current	I_N	A	0.6
Moment of inertia	J_B	kgm ²	0.38 x 10 ⁻⁴
Release delay	t_L	ms	30
Clamping delay	t_K	ms	15
Mass	m_B	kg	0.55

Fig 6.3: Technical data - blocking brake

www.motion-electronic.com

6.2. Torque-Speed Characteristics

MDD 065 A at
4000 min⁻¹

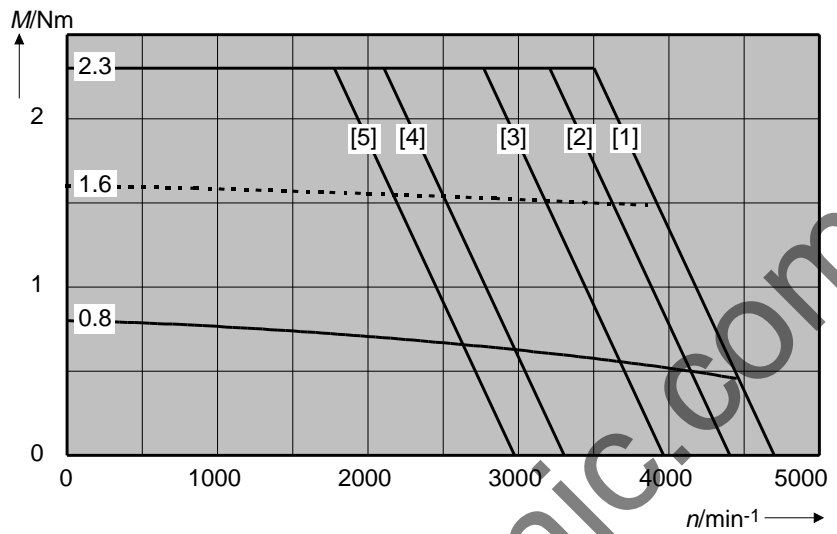

MDD 065 A at
6000 min⁻¹

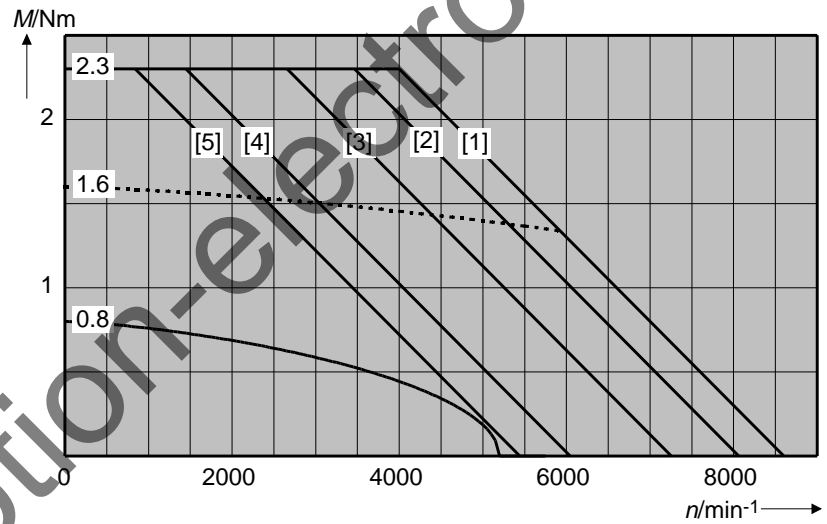

MDD 065 B at
4000 min⁻¹

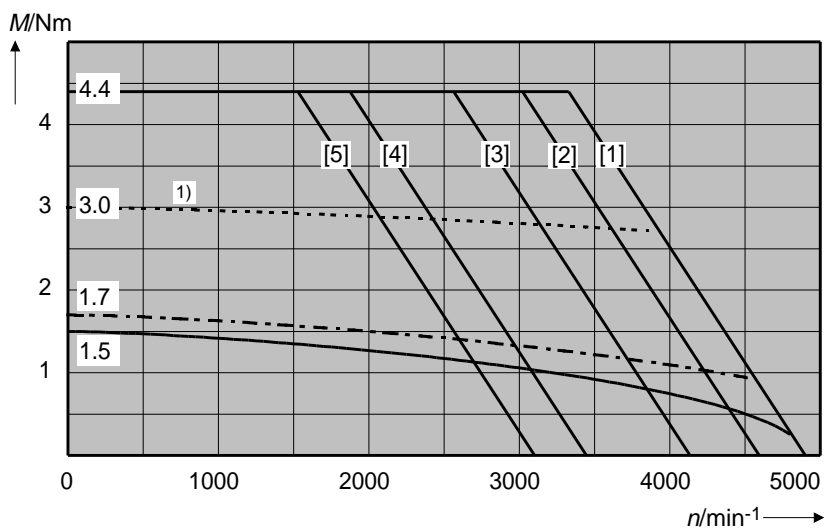

¹⁾ Shown: ON time of surface-cooled motor equals 40%.

Fig 6.4: Torque-speed characteristics curves - MDD 065

MDD 065 B at
6000 min⁻¹

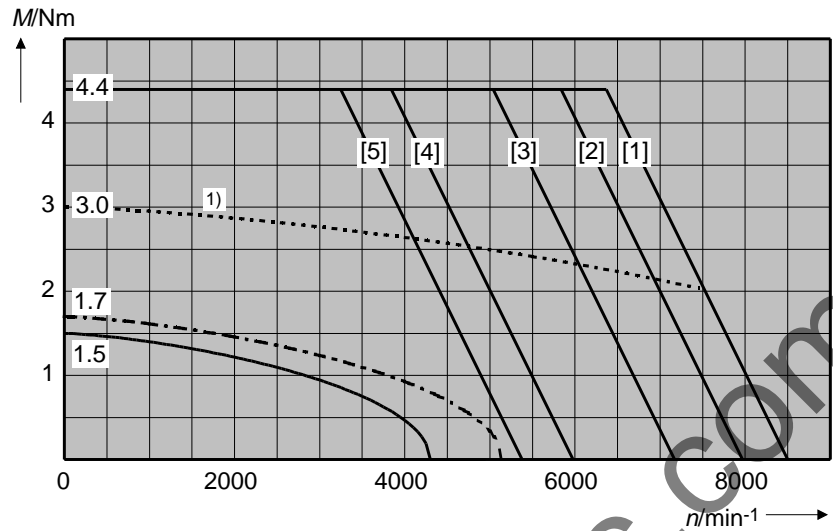

MDD 065 C at
4000 min⁻¹

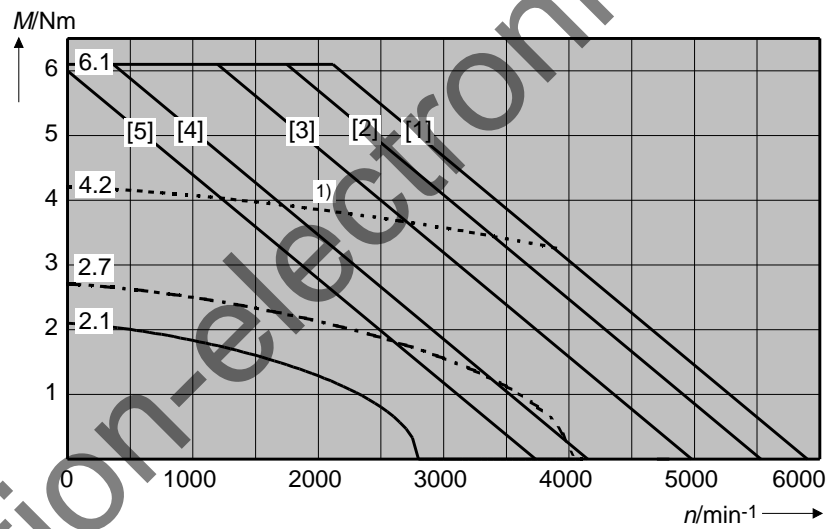

MDD 065 C at
6000 min⁻¹

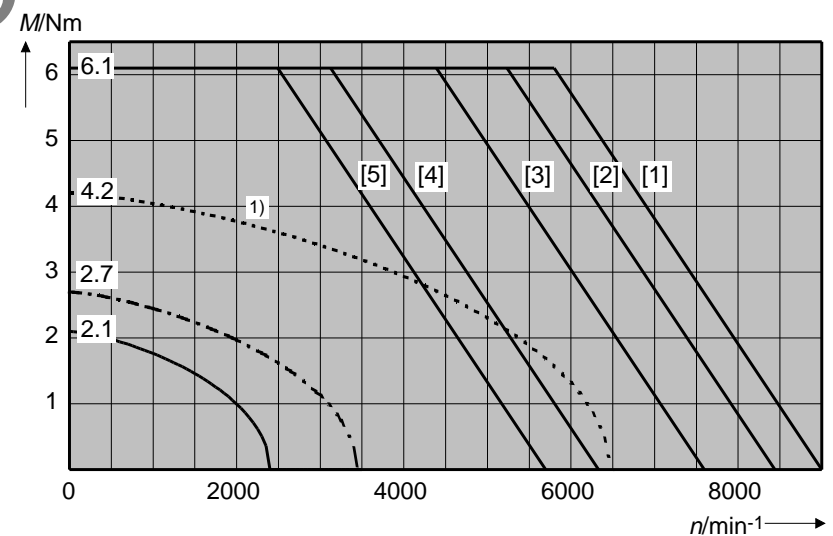

1) Shown: ON time of surface-cooled motor equals 40%.

Fig 6.5: Torque-speed characteristics curves - MDD 065

MDD 065 D at
4000 min⁻¹

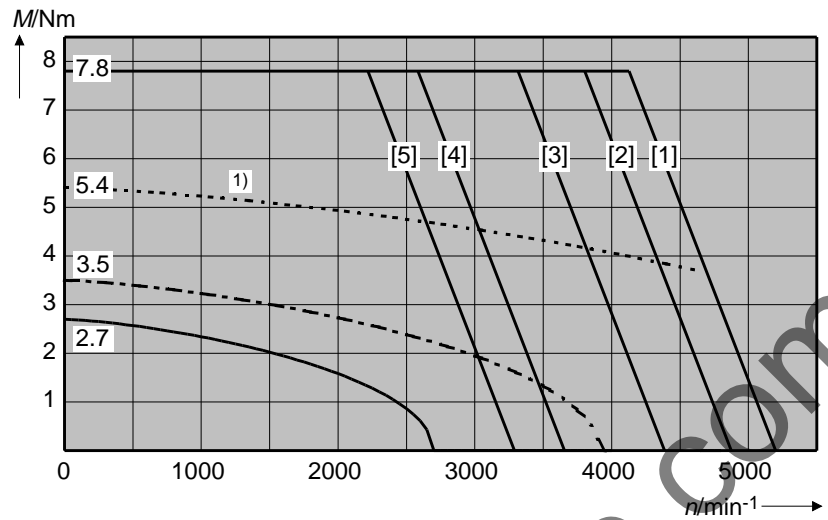

MDD 065 D at
6000 min⁻¹

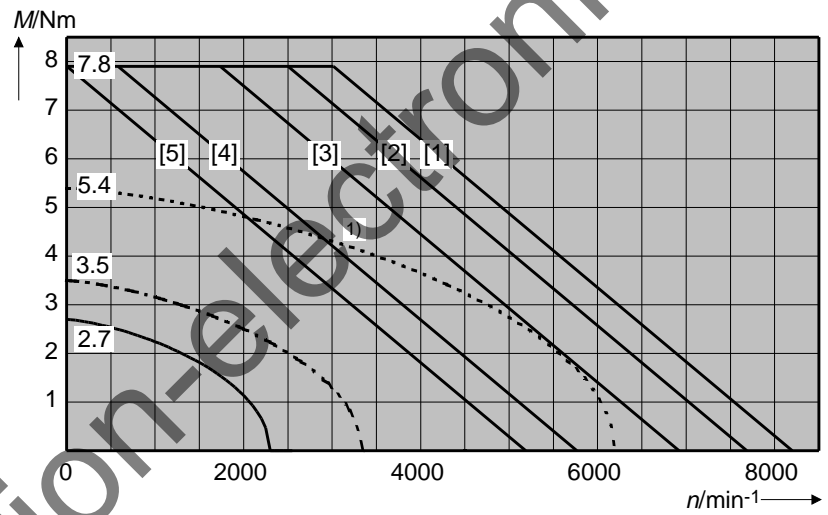

1) Shown: ON time of surface-cooled motor equals 40%.

Fig 6.6: Torque-speed characteristics curves - MDD 065

6.3. Shaft Load Capacity

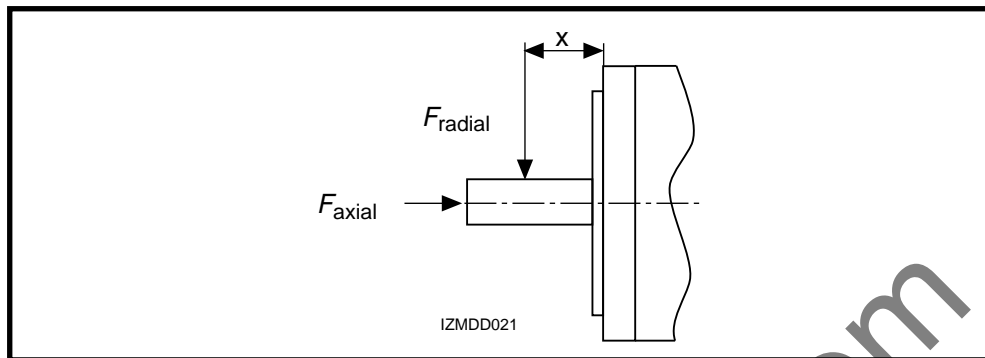

Fig 6.7: Shaft load

Permissible radial force

F_{radial}

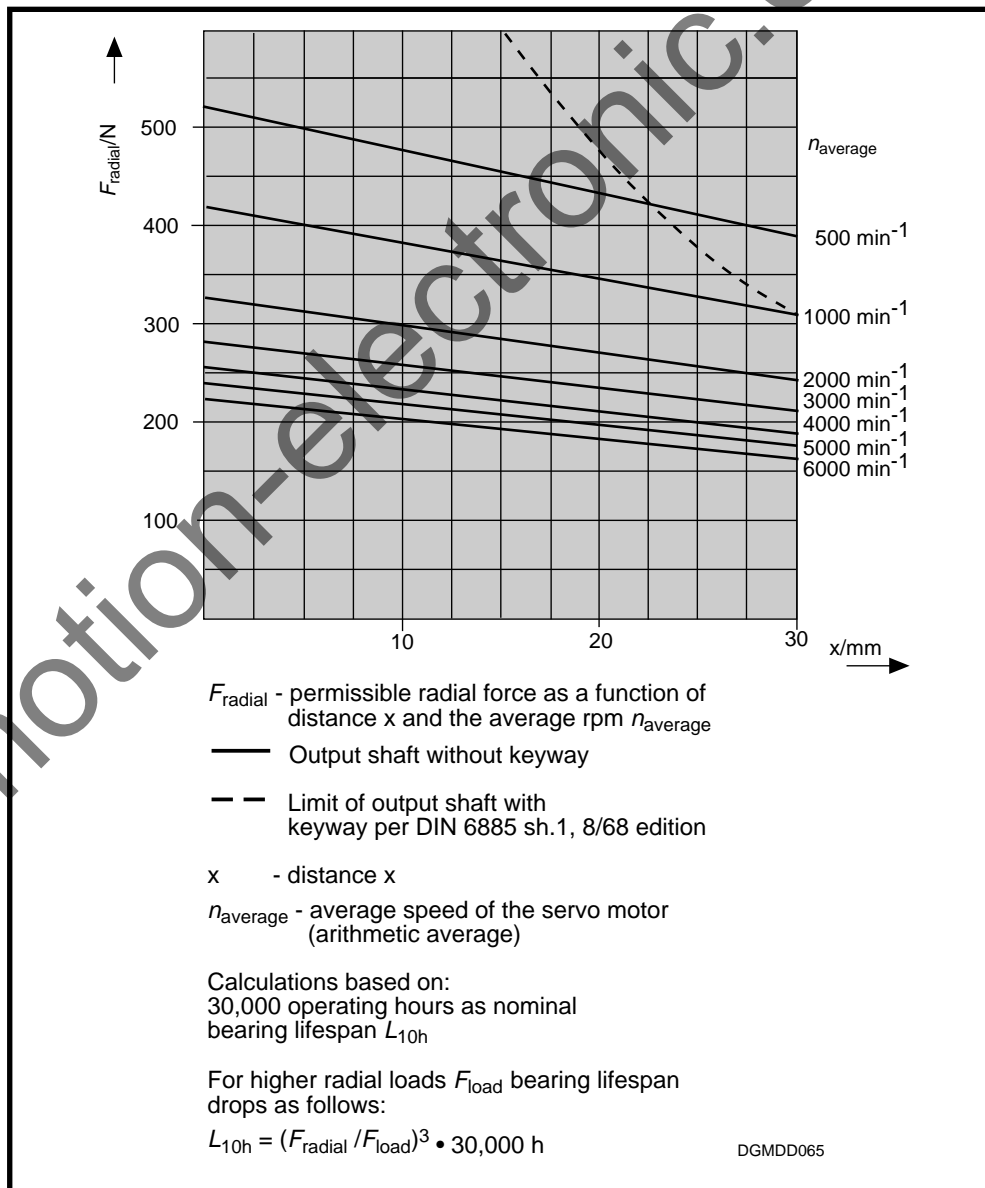

Fig 6.8: Permissible radial force

Permissible axial force

F_{axial}

$$F_{axial} = 0.57 \cdot F_{radial}$$

F_{axial} - permissible axial force

F_{radial} - permissible radial force

6.4. Dimensional Data

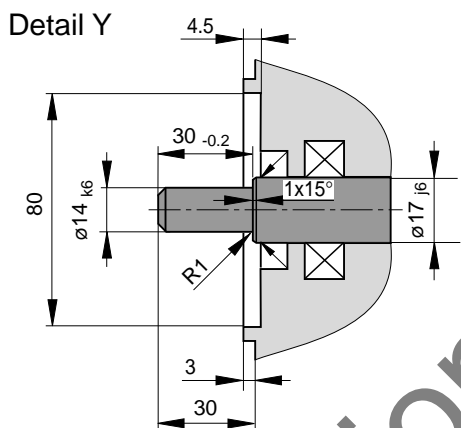
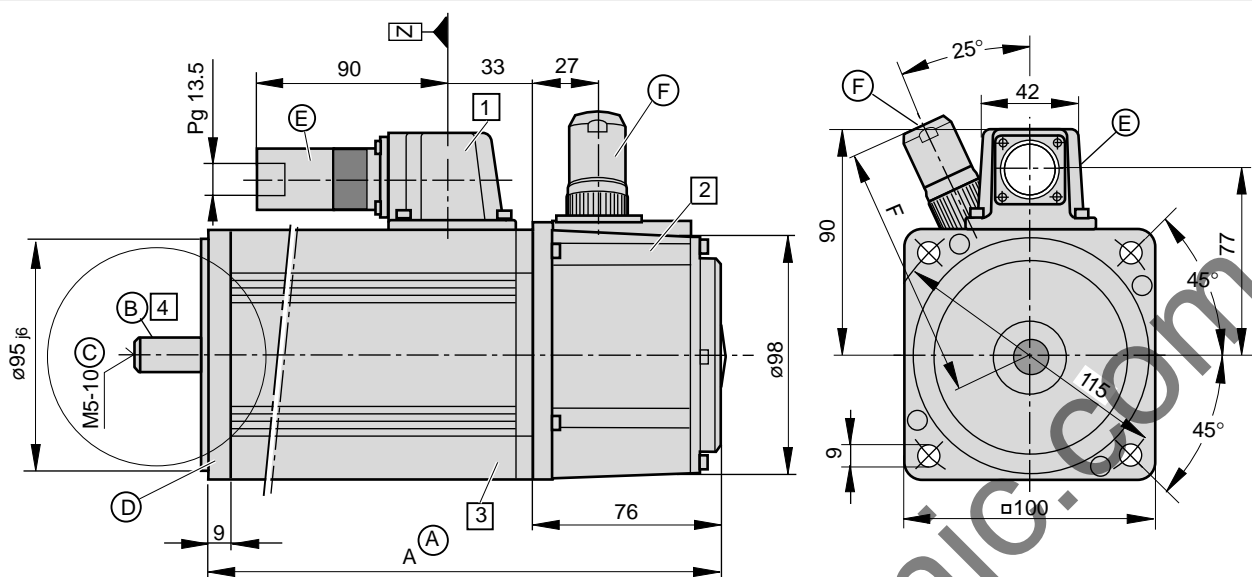

(A) Dimensional table Dim. A

Size	Dim. A ¹⁾
MDD 065 A	163
MDD 065 B	178
MDD 065 C	193
MDD 065 D	208

¹⁾ Bigger with some options.
The then applicable dimension is indicated with the respective feature.

(B) Concentricity, excentricity and coaxiality to the shaft per DIN 42955, tolerance class R, 12/81 edition.

- (C)**
 - Shaft end per DIN 748 section 3, 7/75 edition, IEC 72, 1971 edition, cylindrical
 - Center hole DS M3-8 per DIN 332 section 2, 5/83 edition
 - Max. tightening torque M_A for screws in the threads of the center hole: 1 Nm
 - Balance class N per DIN VDE 0530 section 14, 2/93 edition

- (D)** Flange type per DIN 42948, 11/65 edition, makes mounting possible
 - as per design B5 (throughholes in flange)
 - as per design B14 (threads in flange)

- (E) Motor power connector**
INS 252 must be ordered separately.

- (F) Feedback connector:**
INS 513 and INS 512 must be ordered separately as possible types.

Table of dimensions:

Name	Connector type	Dim. F
straight conn.	INS 513	110
	INS 512	112
angle conn.	INS 511	108
	INS 510	

MBMDD065_1

Fig 6.9: Dimensional data - MDD 065

Available Options

1 Power connection

The output direction of the electrical power connector is selected at the time the order is placed. Possible output direction is either:

- side A or
- side B
- to the right
- to the left

The drawing depicts side A as output direction. The dimensions of any other output direction are obtained by virtually turning the connector housing around the Z axis.

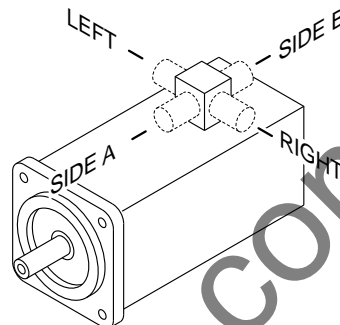

2 Motor feedback

- Digital servo feedback (DSF)
 - Digital servo feedback (DSF) with integrated multturn absolute encoder
- The dimensions are identical.

3 Blocking brake

- without blocking brake
- with blocking brake: 3.0 Nm

Dimensional table for motors with blocking brake

Size	Dim. A
MDD 065 A	187
MDD 065 B	202
MDD 065 C	217
MDD 065 D	232

4 Output shaft

- plain shaft (preferred type)
- with keyway per DIN 6885 sheet 1, 8/68 edition
(Note: balanced with entire key!)

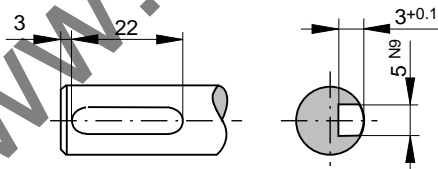

Matching key: DIN 6885-A 5 x 5 x 22

MBMDD065_2

Fig 6.10: Dimensional data - MDD 065 - available options

6.5. Available Versions

Type code field:	Example:	MDD	065	B-N	040	N	2	L	095	G	B	0
1. Name Motor for digital drive controllers	MDD											
2. Motor size	065											
3. Motor length	A, B, C, D											
4. Housing design: Standard (suited for natural convection and surface-cooling)	N											
5. Nominal speed 4000 min ⁻¹ 6000 min ⁻¹	040 060											
6. Balance class Standard (R per DIN VDE 0530 section 14, 2/93 edition)	N											
7. Side B shaft end Standard (without side B shaft end)	2											
8. Motor feedback digital servo feedback digital servo feedback with integrated multiturn absolute encoder	L M											
9. Centering diameter ø095 mm	095											
10. Output shaft plain shaft shaft with keyway per DIN 6885 sh. 1, 8/68 edition	G P											
11. Power connection connector to side A connector to side B connector to the right (looking onto motor shaft, connecting housing at top) connector to the left (looking onto motor shaft, connecting housing at top)	A B R L											
12. Blocking brake without blocking brake with 3.0 Nm blocking brake	0 1											

Quelle: INN 41.60 TLMD065

Fig 6.11: Type codes - MDD 065